



Common Mode Choke ~ CMT2207B SERIES



RoHS Compliant

PART NUMBERING SYSTEM

<u>CMT</u>	<u>2207B</u>	—	<u>581N</u>	—	<u>LF</u>
TYPE	DIMENSIONS		IMPEDANCE		LEAD FREE

SHAPES AND DIMENSIONS

UNIT : mm

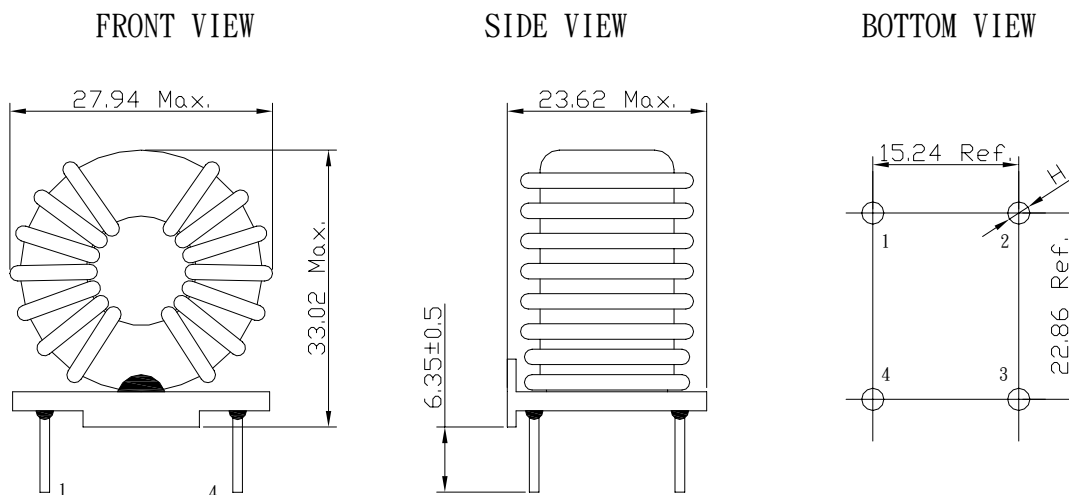

SCHEMATIC DRAWING

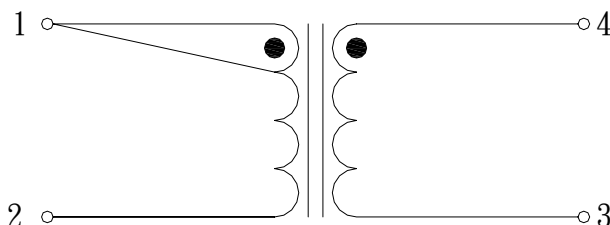



Common Mode Choke ~ CMT2207B SERIES



RoHS Compliant

SPECIFICATION TABLE

PART NUMBER	INDUCTANCE (mH)	DCR (mΩ) (max)	I _{rms} (A) (max)	TEST FREQ. (f)	Dimension H(mm)
CMT2207BF-121N-LF	0.129±30%	1.44	25.9	10KHz	2.08
CMT2207BF-231N-LF	0.231±30%	2.73	18.8	10KHz	1.88
CMT2207BF-291N-LF	0.292±30%	3.26	17.2	10KHz	1.70
CMT2207BF-361N-LF	0.361±30%	3.80	15.9	10KHz	1.55
CMT2207BF-611N-LF	0.610±30%	6.39	12.3	10KHz	1.40
CMT2207BF-701N-LF	0.707±30%	9.27	10.2	10KHz	1.02
CMT2207BF-102N-LF	1.04±30%	13.56	8.4	10KHz	1.17
CMT2207BF-112N-LF	1.16±30%	17.40	7.4	10KHz	1.07
CMT2207BF-142N-LF	1.44±30%	24.47	6.3	10KHz	0.97
CMT2207BF-172N-LF	1.74±30%	32.59	5.4	10KHz	0.89
CMT2207BF-192N-LF	1.90±30%	42.70	4.8	10KHz	0.81
CMT2207BF-242N-LF	2.44±30%	60.9	4.0	10KHz	0.76
CMT2207BF-362N-LF	3.69±30%	99.26	3.1	10KHz	0.71
CMT2207BT-251N-LF	0.259±30%	1.44	25.9	10KHz	2.08
CMT2207BT-461N-LF	0.462±30%	2.73	18.8	10KHz	1.88
CMT2207BT-581N-LF	0.584±30%	3.26	17.2	10KHz	1.70
CMT2207BT-721N-LF	0.722±30%	3.80	15.9	10KHz	1.55
CMT2207BT-122N-LF	1.22±30%	6.39	12.3	10KHz	1.40
CMT2207BT-142N-LF	1.41±30%	9.27	10.2	10KHz	1.02
CMT2207BT-202N-LF	2.08±30%	13.56	8.4	10KHz	1.17
CMT2207BT-232N-LF	2.33±30%	17.40	7.4	10KHz	1.07
CMT2207BT-282N-LF	2.88±30%	24.47	6.3	10KHz	0.97
CMT2207BT-342N-LF	3.49±30%	32.59	5.4	10KHz	0.89
CMT2207BT-382N-LF	3.81±30%	42.70	4.8	10KHz	0.81
CMT2207BT-482N-LF	4.88±30%	60.9	4.0	10KHz	0.76
CMT2207BT-732N-LF	7.39±30%	99.26	3.1	10KHz	0.71

- Inductance is measured with a LCR meter 4284A or equivalent.
- Test voltage : 1500V, 50Hz , 5mA , 2sec.
- Operating temperature range -40°C to +125°C
- Electrical specifications at 25°C