



SBS0703 SERIES ~ Shielded SMD Power Inductors



RoHS Compliant

PART NUMBERING SYSTEM

SBS	0703	—	100M	—	LF
TYPE	DIMENSIONS		INDUCTANCE		LEAD FREE

SHAPES AND DIMENSIONS

UNIT : mm

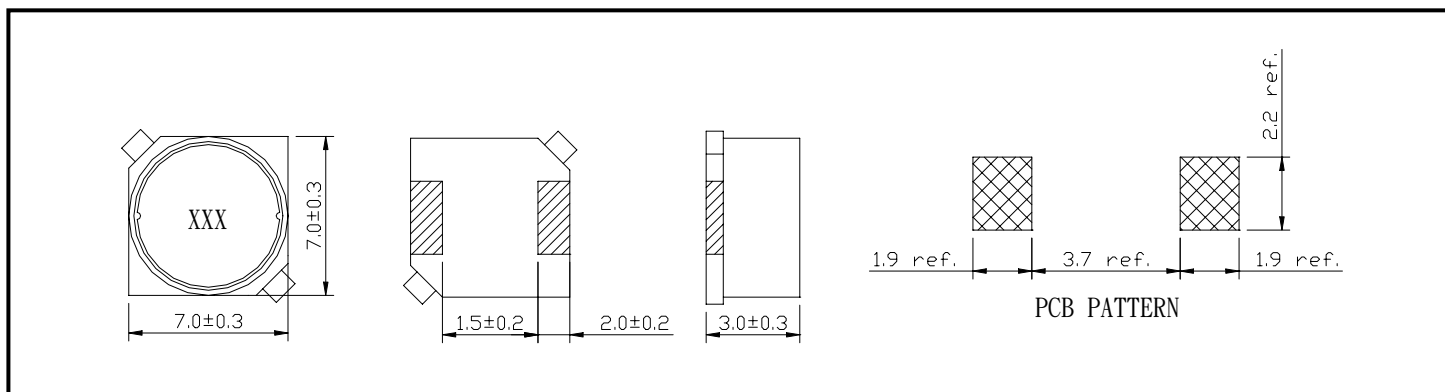

PACKAGING SPECIFICATION

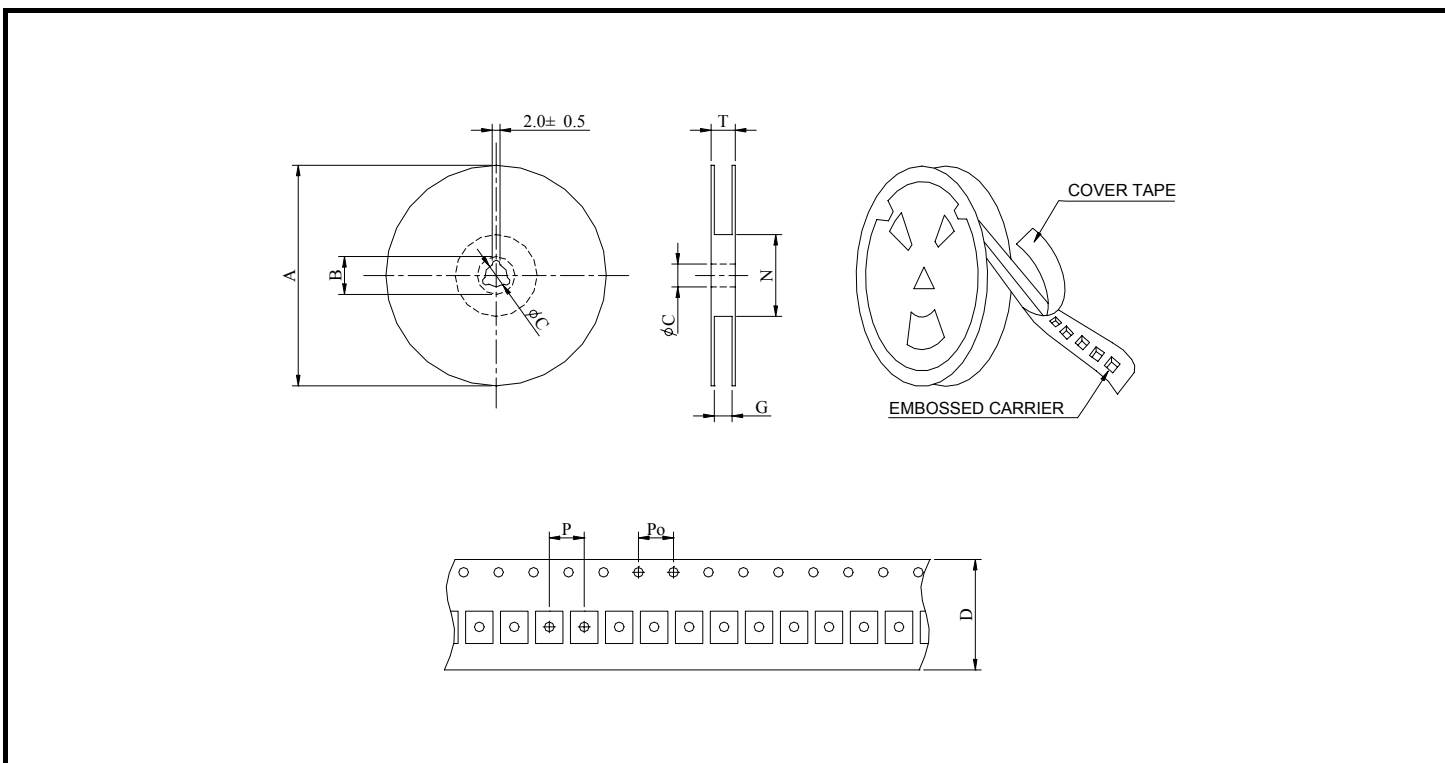

SERIES	STAYLE	Q' TY (PCS)	DIMENSIONS (m/m)								
			A	B ± 0.8	C ± 0.5	D	G $^{+0}$	N 0	P	P $_0$	T
SBS0703	13-16	1000	330	21	13	16	18	50	12	4	22.4



SBS0703 SERIES ~ Shielded SMD Power Inductors



RoHS Compliant

SPECIFICATION TABLE

PART NUMBER	INDUCTANCE (μ H)	DCR (Ω) (Max.)	IDC (A) (Max.)	TEST FREQ. (f)
SBS0703-1R0M-LF	1.0 \pm 20%	0.019	3.25	100KHz
SBS0703-1R5M-LF	1.5 \pm 20%	0.023	3.00	100KHz
SBS0703-2R2M-LF	2.2 \pm 20%	0.033	2.55	100KHz
SBS0703-3R3M-LF	3.3 \pm 20%	0.035	2.40	100KHz
SBS0703-4R7M-LF	4.7 \pm 20%	0.046	2.10	100KHz
SBS0703-6R8M-LF	6.8 \pm 20%	0.060	1.90	100KHz
SBS0703-100M-LF	10 \pm 20%	0.090	1.50	100KHz
SBS0703-120M-LF	12 \pm 20%	0.120	1.45	100KHz
SBS0703-150M-LF	15 \pm 20%	0.130	1.20	100KHz
SBS0703-180M-LF	18 \pm 20%	0.150	1.15	100KHz
SBS0703-220M-LF	22 \pm 20%	0.190	1.05	100KHz
SBS0703-270M-LF	27 \pm 20%	0.200	1.00	100KHz
SBS0703-330M-LF	33 \pm 20%	0.280	0.90	100KHz
SBS0703-390M-LF	39 \pm 20%	0.300	0.80	100KHz
SBS0703-470M-LF	47 \pm 20%	0.340	0.75	100KHz
SBS0703-560M-LF	56 \pm 20%	0.440	0.68	100KHz
SBS0703-680M-LF	68 \pm 20%	0.500	0.65	100KHz
SBS0703-820M-LF	82 \pm 20%	0.680	0.60	100KHz
SBS0703-101M-LF	100 \pm 20%	0.760	0.50	100KHz
SBS0703-121M-LF	120 \pm 20%	0.840	0.48	100KHz
SBS0703-151M-LF	150 \pm 20%	0.940	0.45	100KHz
SBS0703-181M-LF	180 \pm 20%	1.300	0.38	100KHz
SBS0703-221M-LF	220 \pm 20%	1.500	0.35	100KHz
SBS0703-271M-LF	270 \pm 20%	2.400	0.30	100KHz
SBS0703-331M-LF	330 \pm 20%	2.600	0.28	100KHz
SBS0703-391M-LF	390 \pm 20%	3.000	0.25	100KHz
SBS0703-471M-LF	470 \pm 20%	3.300	0.23	100KHz
SBS0703-561M-LF	560 \pm 20%	5.700	0.20	100KHz
SBS0703-681M-LF	680 \pm 20%	6.100	0.18	100KHz
SBS0703-821M-LF	820 \pm 20%	6.700	0.17	100KHz
SBS0703-102M-LF	1000 \pm 20%	7.400	0.16	100KHz

- DC current at which the inductance drops 10% (typ) from its value without current.
- Operating temperature range -20°C to +85°C
- Electrical specifications at 25°C.